

User Manual
pulsFOG TracFOG 100 F
Tractor Mounted ULV Fogger



pulsFOG®

pulsFOG Dr. Stahl & Sohn GmbH.

Abigstrasse 8 / 88662 Überlingen / Germany
Tel: +49 7551 92610 – E-Mail: info@pulsfog.com
www.pulsfog.com

CONTENTS

1. PREPARING AND OPERATING THE UNIT	3
1.1. SUPPLIED ITEMS	3
1.2. PREPARATIONS BEFORE OPERATION	3
1.3. CAUTION WITH THE FORMULATION PUMP	4
1.4. FITTING THE UNIT TO THE TRACTOR	5
1.5. INSTALLING THE DRIVE SHAFT	6
1.6. CONNECTING THE UNIT TO 12 VDC POWER	8
1.7. FILLING THE FORMULATION TANK	8
1.8. SETTING THE NOZZLE POSITION	10
1.9. THE CONTROL PANEL	10
1.10. RUNNING THE UNIT	10
1.11. OPERATING SEQUENCE	11
1.12. CHECKING AND SETTING THE FLOW RATE	12
1.13. THE TRACFOG 400 F HYDRAULIC SYSTEM	13
2. SAFETY AND CARE	15
2.1. RECOMMENDED PROTECTIVE GEAR	15
2.2. CAUTION WITH THE DRIVESHAFT	15
2.3. CARE DURING OPERATION	15
3. MAINTENANCE	16
3.1. OIL CHECK AND CHANGE SCHEDULE	16
3.2. CHECKING THE FORMULATION AND AIR FILTERS	18
3.3. SETTING AND MAINTAINING THE REVERSION SYSTEM	20
3.4. OTHER PERIODIC CHECKS	31
3.5. SERVICING SCHEDULE	34
3.6. TRACFOG 400 F WIRING DIAGRAM	35

1. PREPARING THE UNIT FOR OPERATION

1.1. SUPPLIED ITEMS. The TracFOG 100 F fogger is delivered with following items:

- 1 complete fogging unit;
- 1 complete driveshaft;
- 1 driveshaft guard;
- 2 complete lower 3 point quick-hitch bolts;
- 1 complete 3rd point bolt;
- 1 set of dosing nozzles;
- 1 user manual.



1.2. PREPARATIONS BEFORE OPERATION. Before operating the unit, following procedures must be carried out:

1.2.1. Correct mounting of the hitch bolts – In order to reduce packing dimensions, the two lower 3-point hitch bolts are mounted inwards. Before the unit is hitched to the tractor, the bolts must be mounted outwards, like shown below.

ATTENTION! Observe correct mounting of the lower hitch bolts before operation!

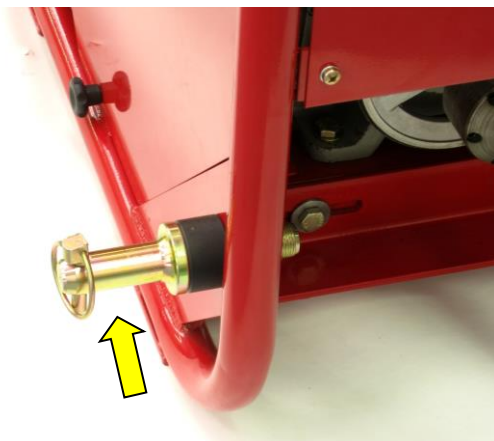

1.2.2. The pulsFOG TracFOG 100 F is delivered ready to use and filled with lubricant. However, before operating the unit we recommend to check the oil levels of the components, like described further in the text. Place the unit on a leveled surface and remove its side guards to perform this checking. To avoid injury hazard, make sure the driveshaft is disconnected,

so the unit cannot be started by accident during the checking.
Refer to Section 3 in this manual for information about oil check and change frequency, recommended oil types and related procedures.

ATTENTION! Do not run the unit if any of its guards are not in place, as there is severe injury hazard caused by moving parts such as wheels and belts.

1.2.3. Check the tension of the blower and pump drive belts. Pressed by hand, they should yield about 10 mm. For instructions to set the belt tension, refer to section 3.4.1.

1.3. CAUTION WITH THE FORMULATION PUMP. The formulation pump of the TracFOG 100 F fogger should not run dry. Fill the formulation tank with at least 10 L of formulation before starting the equipment and make sure the formulation ball valves are opened, as shown on the pictures below. Do not run the equipment if these ball valves are shut, which could damage de pump.

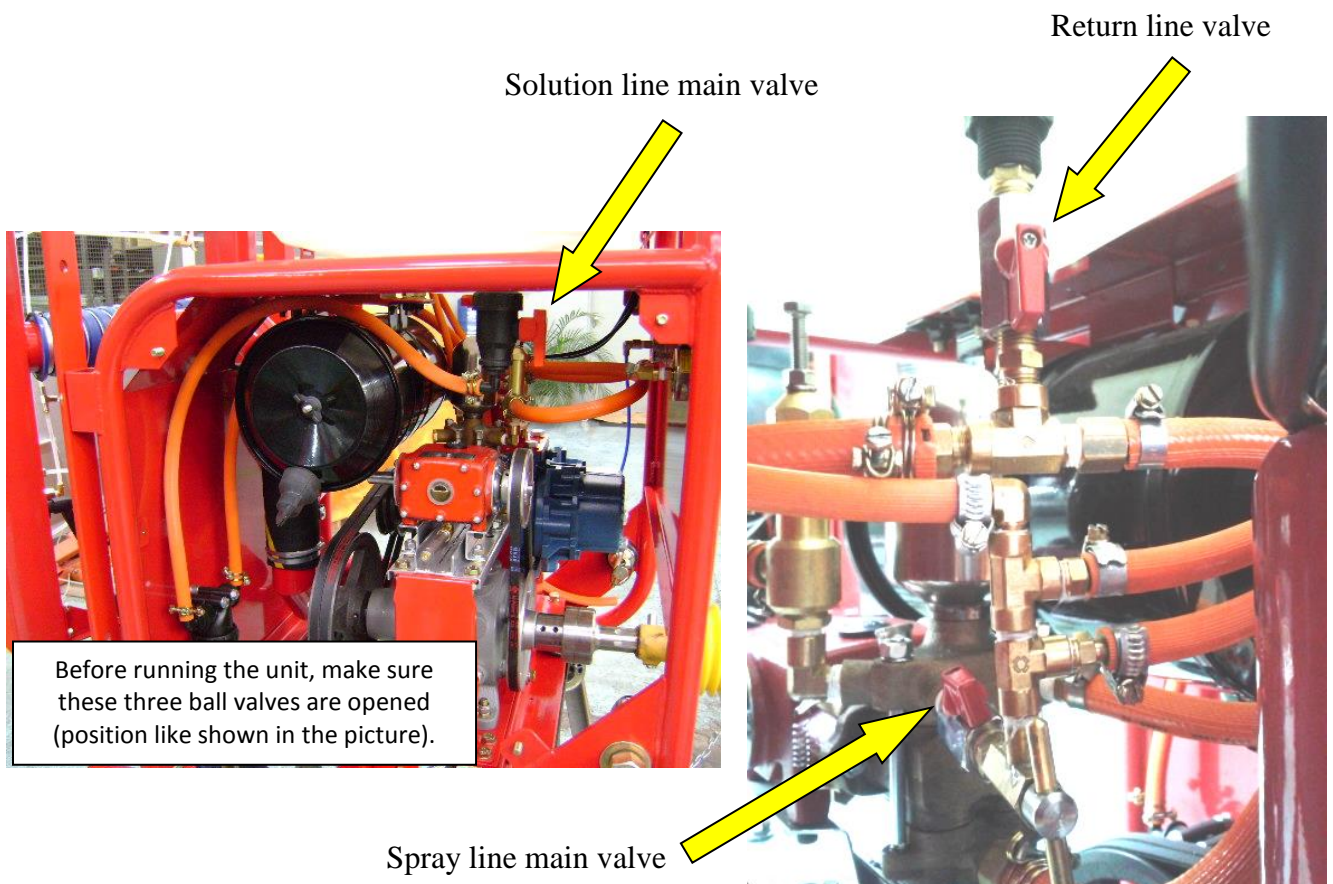

1.4. FITTING THE UNIT TO THE TRACTOR. After the procedures described above, fasten the side guards securely to the equipment. The machine must be fitted to an agricultural tractor with at least 50 HP, equipped with hydraulic 3-point hitch system and 540 rpm clockwise turning PTO shaft. The 3rd point extension bar should be set so that the unit becomes leveled when lifted about 40-50 cm above the ground. Running the unit unlevelled may damage the driveshaft and other components.



The unit should be leveled when lifted about 20-50 cm, depending on tractor size.



Incorrect left-right and/or front-rear leveling may damage the equipment.

1.5. INSTALLING THE CARDAN SHAFT. The pulsFOG TracFOG 100 F is supplied with one 50 cm long driveshaft, including 1.3/8"Z6 quick release connectors on both sides and a complete driveshaft guard. Depending on the tractor model it might be necessary to cut the shaft bars to a suitable length. The driveshaft bars (square bar and square tube) should be inserted about 2/3 of their length, measured when the unit is lifted to the running position. In order to avoid excessive wear or failure of the driveshaft links, the tractors PTO and the input shaft should be set to the best possible alignment. The driveshaft links should be lubricated daily. Observe the following pictures:



TracFOG 100 power input shaft.



Complete driveshaft with links, connectors and guard.



Correct mounting of the driveshaft. Fix chains to prevent guard from rotating!

INSTALLATION SEQUENCE:

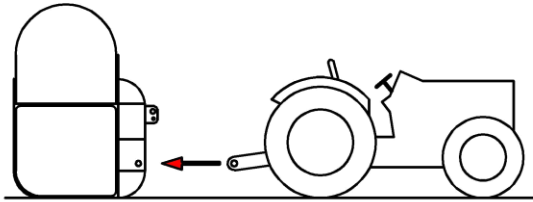

Place the unit on a leveled surface. Make sure the tractor's hydraulic hitch levers are wide enough apart to fit the TracFOG.

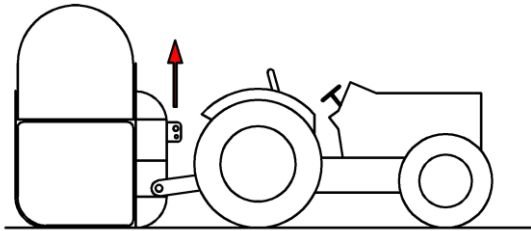

Connect the levers to the left and right hitch bolts on the TracFOG. Do not forget to secure each lever with one of the supplied cotter pins. Lift the unit slightly to facilitate the mounting of the third point rod.

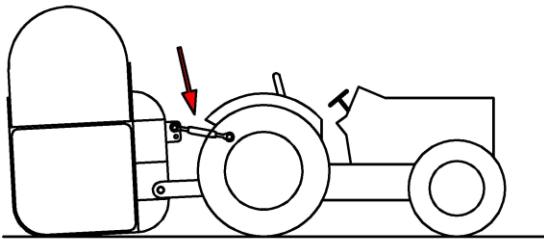

Install the 3rd point rod using the supplied 3rd point bolt. Do not forget to secure the assembly with the cotter pin.

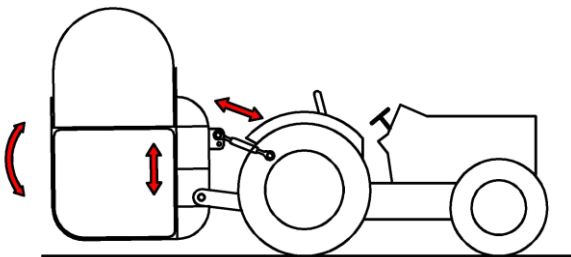

Lift and level the unit by extending or shortening the 3rd point rod. Be careful not to extend the rod too much, or it may disengage and make the unit drop. Level the unit so the PTO shaft and the input shaft of the TracFOG are on the same height and the horizontal deviation between these shafts is as little as possible.

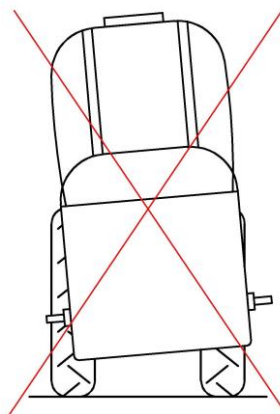
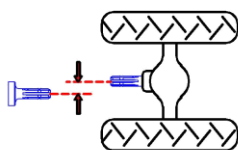
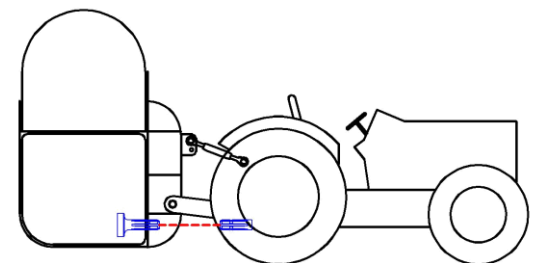

CARDAN SHAFT INSTALLATION:

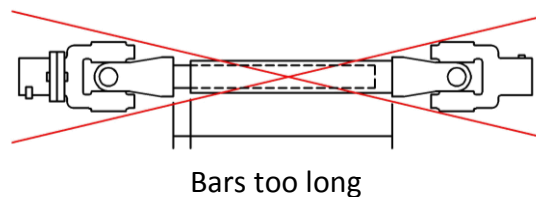
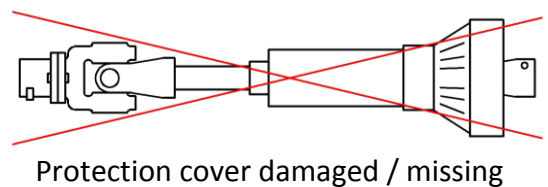
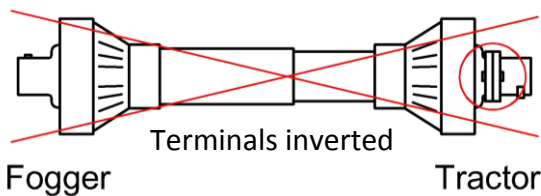
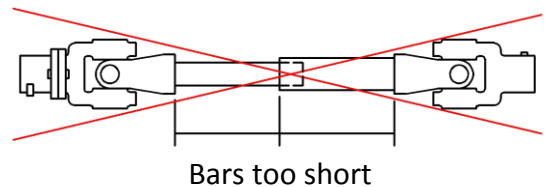
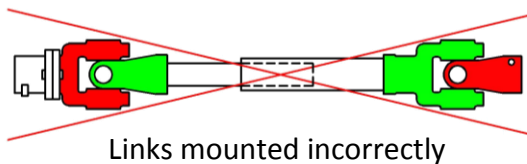
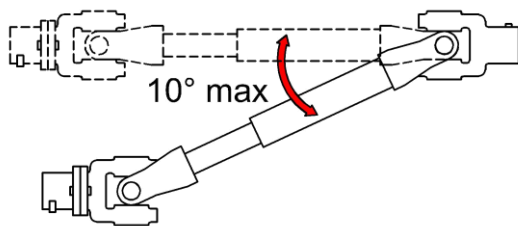
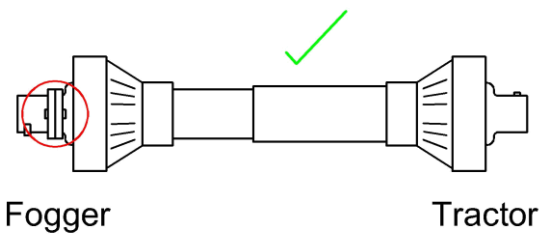
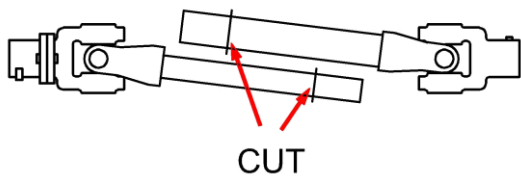
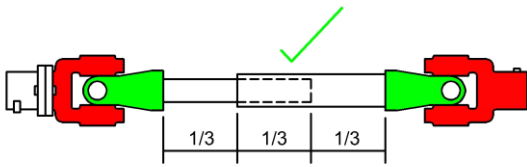

When mounted in place the bars of the cardan shaft should look like on the picture left. If necessary, the bars must be cut to length!

Before cutting the shaft, the unit must be lifted and leveled as described on the previous page!

In order to measure the bars' length, disconnect (pull out) the bars and connect the terminals to the PTO and fogger input shaft. Compare, measure and cut to length if necessary.

For operation, the plastic protective cover must be in place and in perfect condition! The safety device with M6 fuse screw must be mounted on the fogger side.

When mounted in place, the angle between links and bars should not be greater than 10°. Steeper angles may damage the shaft.

CAUTION: DO NOT ADJUST THE UNIT'S HEIGHT WHEN THE PTO IS ENGAGED.

ATTENTION! Do not operate the unit if the shaft guard is damaged, not properly fastened, incomplete or missing, as there is severe injury hazard. Make sure all joints and connectors are integer and properly fixed and the links are not excessively angled, before starting the unit. Repair or substitute the driveshaft immediately if any damage is noticed. Stay away from the driveshaft and do not allow anyone to remain near it when the unit is running or about to be started.

1.6. CONNECTING THE UNIT TO 12VDC POWER

Connect the power cable to a 12VDC automotive battery. Whenever possible, use the own tractor's battery. Place the control panel in the tractor's cabin, within the drivers reach.

Power cable and control panel



1.7. FILLING THE FORMULATION TANK. Make sure the drain valve is shut and the ball valves in the formulation line are open (see section 1.3.). Fill the tank with at least 10 and up to 100 liters of ready and homogenized formulation. The TracFOG 100 F features a bypass system that directs part of the formulation flow generated by the pump back into the tank, providing an agitation effect which helps to avoid decantation when working with suspensions. It is recommended though, to use only perfectly homogeneous and stable formulations, as sediments of solid particles on the bottom of the tank may obstruct the formulation filter, formulation lines, shut-off valves and nozzles. Use the strainer to filter out any larger particles from the formulation. Reinstall the lid after filling. Reinstall the unit's guards after checking the ball valves.



Drain valve (shut)



Formulation tank, strainer and lid

FORMULATION TANK FILLING SEQUENCE

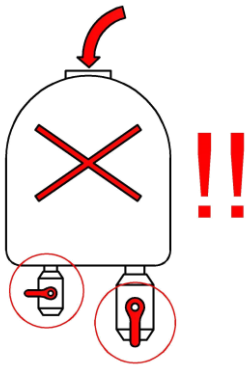

Before filling the tank, close the tank drain valve and open the pump feed line valve! The tank takes up to 100 Liters (25 gal).

For water based solutions and suspensions:

1. Fill the tank with at least 80% of the required amount of water, which should be not less than 7,5 Liters (2 gal).
2. Mix the chemical into a slurry in a separate container.
3. Start PTO and rev up to 540 rpm max.
4. Pour slurry slowly into the tank.
5. If necessary, complete the required volume with water.



For oil based emulsions:

1. Fill the tank with at least 7,5 Liters (2 gal) of water.
2. Start PTO and rev up to 540 rpm max.
3. Slowly pour the entire volume of emusifiable oil into the tank.
4. Mix the chemical into a slurry in a separate container.
5. Pour slurry into the tank.
6. Complete the required volume with water.

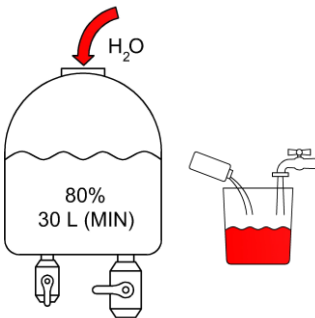

WARNINGS

- Never pour powders, granulates or any other solid formulations directly into the empty tank, which will damage the formulation lines, filters and formulation pump!
- Drain possible formulation remains from the tank immediately after the application. Rinse the tank with clear water immediately afterwards. Start the unit and make the clear water flow through the pump and formulation lines.
- Clean the formulation filters after every application!
- Do not allow the pump to run dry! If the fogging starts failing (formulation level is too low and pump is sucking air), fill in more formulation before continuing the application.
- Use the supplied strainer to avoid large solid particles from getting into the tank!
- Replace the lid after filling the tank to avoid spilling formulation!

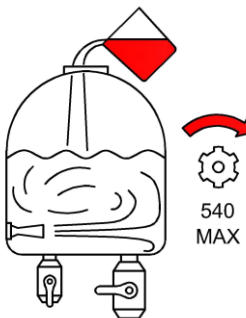
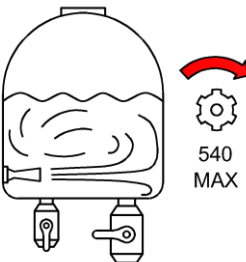

1.8. SETTING THE FOGGING NOZZLES. The TracFOG 100 F features 2 ULV fogging nozzles, which may be set manually to any desired direction. The locking rings (yellow arrows), combined with the pneumatic reversion system, allow the setting of the nozzle elbows. The stroke of the reversing cylinder can be set with the limiter bolts (blue arrow). Loosening the clamp on the fogging boom (green arrow) allows to turn the boom to any desired direction. Be sure to fasten bolts, locking rings and clamp before starting the unit.

After setting the desired nozzle positions, fasten tightly the two locking rings (yellow arrows), the boom clamp (green arrow) and the stroke limiter bolts (blue arrow).

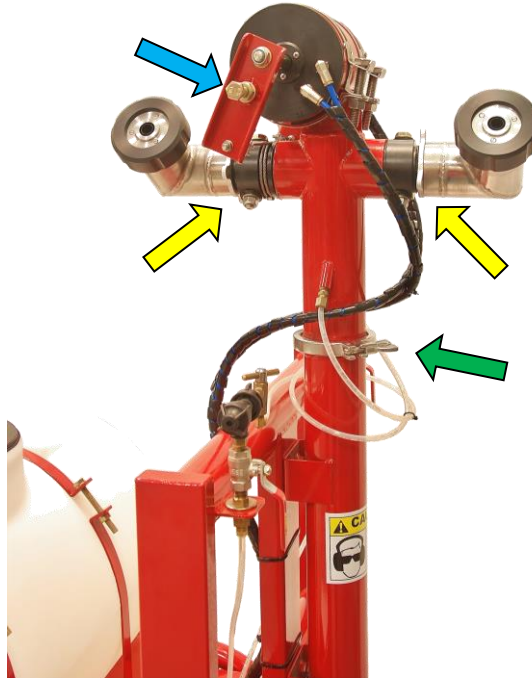

Important Notice: The reversion system requires compressed air from the unit’s blower to operate.

1.9. CONTROL PANEL. The control panel includes independent on-off control switches for the nozzles and the reversion switch.

The TracFOG 100 F control panel



1.10. RUNNING THE UNIT. Before engaging the PTO, make sure to set it to turn clockwise, as some tractors feature reversible PTO's. The PTO shaft must turn counterclockwise (from the driver's seat point of view) or clockwise (looking from the machine towards the rear of the tractor). Before engaging the PTO find the marking on the rev counter, which is equivalent to 540 rpm on the PTO. Some tractors feature 1000 rpm PTO's. The TracFOG should never run with more than 540 rpm.

ATTENTION! Never run the PTO in reverse, which could damage the blower and other components.

ATTENTION! Do not exceed 540 rpm on the PTO. Running the tracFOG with more than 540 rpm may damage the blower and other components. In order to obtain the best possible performance during operation, keep the tractor's engine speed as close as possible to the standard operation speed. The air pressure at the blower's outlet should not exceed 0,6 kg/cm² (check the pressure using the pressure gauge).



1.11. OPERATING SEQUENCE

1 – START ENGINE (IDLE) / CHECK HEIGHT

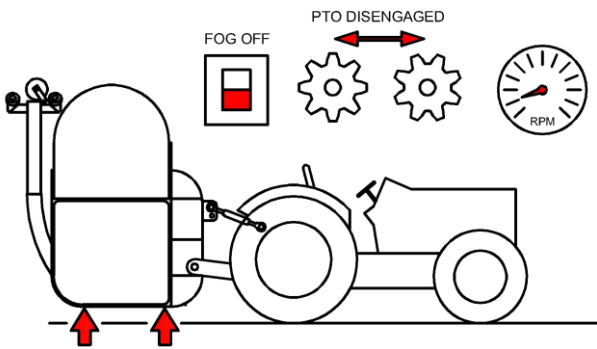

2 – SMOOTHLY ENGAGE PTO

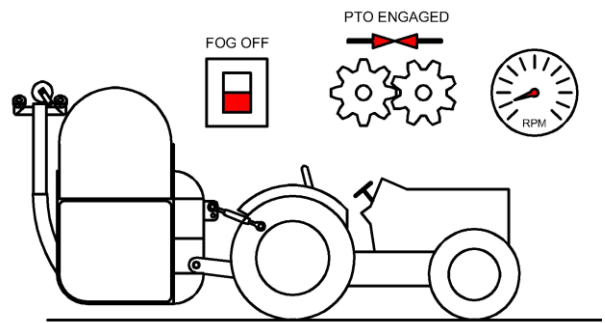

3 – REV UP (540 RPM MAX!)

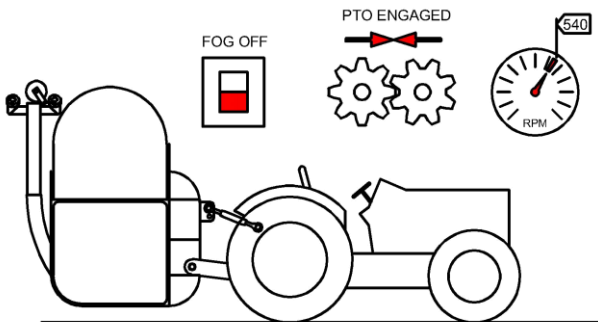

4 – START FOGGING

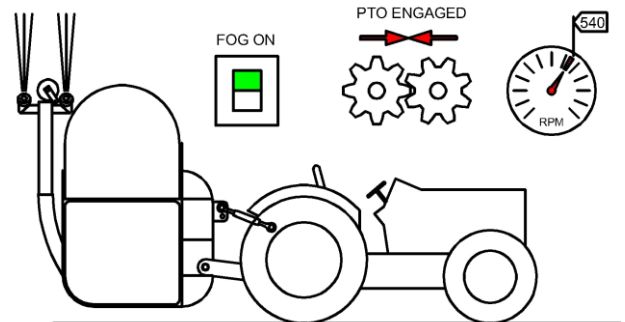

5 – STOP FOGGING

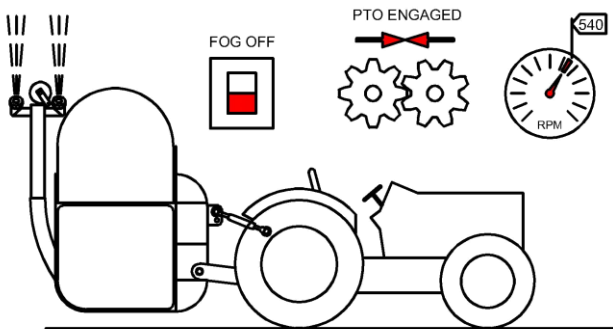

6 – REV DOWN

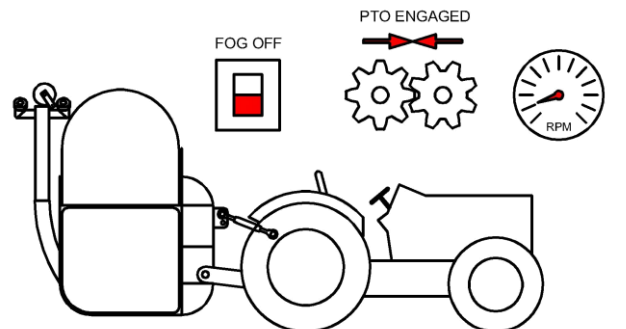

7 – DISENGAGE PTO

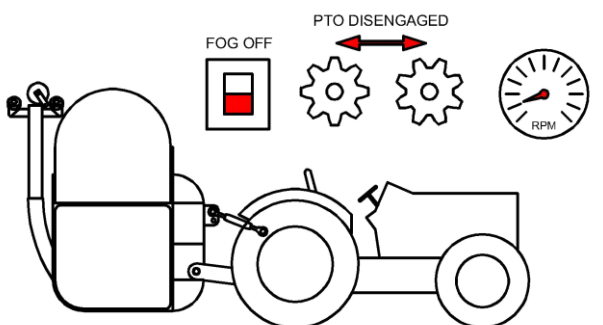

8 – STOP ENGINE

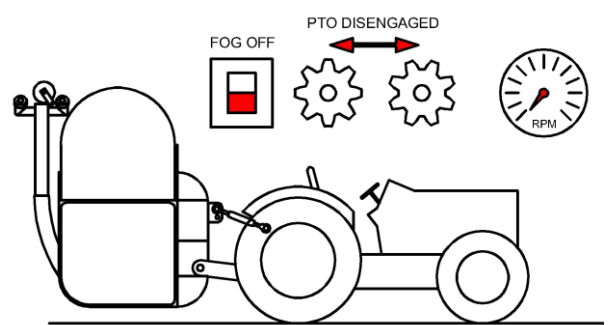

1.12. CHECKING AND SETTING THE FLOW RATE. The formulation flow rate of the TracFOG 100 F fogger is controlled by exchangeable dosing jets. A basic set of dosing jets is supplied with the equipment. The best way to check the formulation flow rate is to fill the tank with a known amount of formulation (e.g. 10 liters) and let the unit run for a predefined amount of time (e.g. 5 min), then draining the remaining formulation from the tank. The consumed formulation volume divided by the running time will result the flow rate.

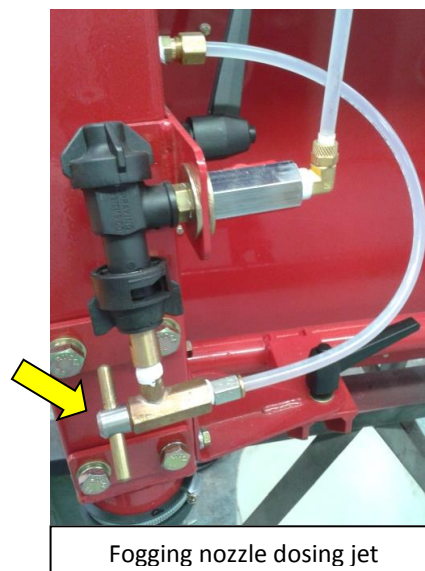
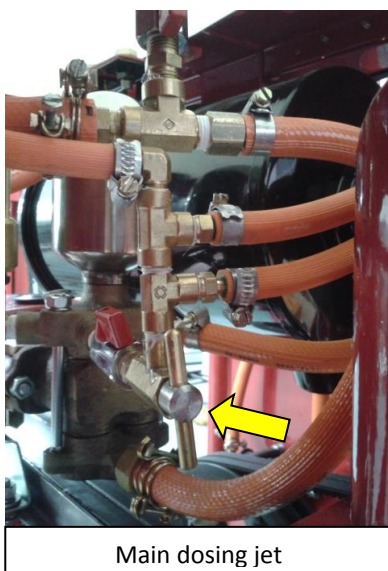

Approximate flow rates with different restriction jets using water as formulation:

“G” and “F” version (2 nozzles):

Main jet #	Nozzle jet #	Flow rate / nozzle (q)	Total flow rate (Q)
#13	2 x #9	580 ml/min	1160 ml/min
#18	2 x #10	830 ml/min	1660 ml/min

“6” version (6 nozzles):

Main Jet #	Nozzle jet #	Flow rate / nozzle (q)	Total flow rate (Q)
#13	6 x #6	250 ml/min	1500 ml/min
#25	6 x #7	480 ml/min	2880 ml/min

Other jet combinations and flow rates are possible. The formulation pressure should remain within the green field on the pressure gauge. When the spray is turned off the pressure should be around 85 psi, the upper limit of the ideal pressure range. When spraying is turned on the pressure should not drop below the lower limit of 35 psi.



1.13. TRACFOG 100 F HYDRAULIC SYSTEM

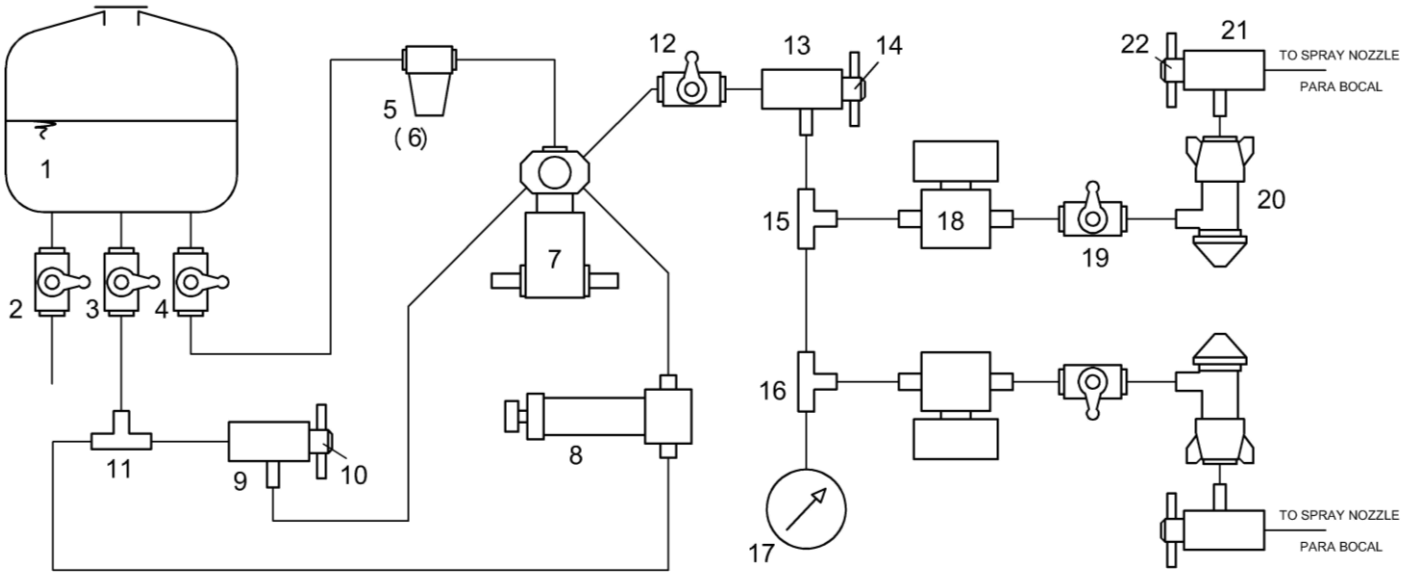

ITEM	DESCRIPTION	REF.	QTY.
1	Formulation tank	C00741.00	1
2	Drain valve	C00354.00	1
3	Return valve	C00062.00	1
4	Outlet valve	C00507.00	1
5	Inline filter (complete)	C00459.00	1
6	Inline filter (strainer)	C00671.00	1
7	Formulation pump	C00740.00	1
8	Safety valve (100 psi)	C00701.00	1
9	Dosing jet seat 11/16"	???	1
10	Dosing jet (return line)	A00075.00	1
11	Threaded T connector ¼ NPT	C00092.00	1
12	Spray line valve	C00062.00	1
13	Dosing jet seat 11/16"	???	1
14	Dosing jet (main jet)	A00075.00	1
15/16	Threaded T connector ¼ NPT	C00092.00	2
17	Spray pressure gauge	C00734.00	1
18	2-way solenoid valve	C00596.00	2
19	Spray nozzle shut off valve	C00062.00	2
20	Anti-drip valve	C00581.00 + C00582.00	2
21	Dosing jet seat 9/16"	???	2
22	Fogging nozzle dosing jet	A00075.00	2

2. CARE AND SAFETY

- 2.1. RECOMMENDED PROTECTIVE GEAR.** Always use all recommended PPE's (personal protective equipment) during preparation of the solution, application and cleaning or washing of equipment. The tractor driver must use full-face respirator with filter-class compatible with the formulation applied. It is recommended to use a tractor with enclosed cab.
- 2.2. CARE WITH THE CARDAN SHAFT.** Follow all local regulations and safety guidelines regarding driveshaft shafts. Do not use the driveshaft without its guard. Use the chains to fix both sides of the guard to the tractor and to the machine. Stop application immediately if noticing any malfunction of the driveshaft or its guard. Before starting the operation, make sure that the driveshaft is properly mounted and that the connectors are firmly seated and locked.
- 2.3. CARE TO OPERATE THE EQUIPMENT.**
- 2.3.1.** Before starting the equipment, make sure that all guards are properly mounted and fixed.
 - 2.3.2.** Do not exceed the standard speed of 540 rpm at the PTO. Excessive speed may damage the equipment.
 - 2.3.3.** Check the oil level on gearbox, blower and spray pump daily. Observe the oil change schedule as shown ahead on Section 3.4. Regularly check the air and formulation filters, as well as the spray pump and blower drive belts tension and wear.
 - 2.3.4.** The TracFOG 100 F should be operated only by professional and trained personnel.

ATTENTION! Do not perform any servicing while the equipment is running and disconnect the driveshaft from the tractor before starting any servicing, as there is severe injury hazard.

ATTENTION! Do not remove any guards from the equipment while it is running and do not start the equipment if any of its guards is missing or not properly fixed, as there is severe injury hazard.

3. MAINTENANCE

3.1. OIL CHECK AND CHANGE SCHEDULE

The TracFOG 100 F fogger is supplied with all oil pans adequately filled. However, before starting the unit, check the oil level at the following 4 points, and fill with oil if necessary. To check oil levels the equipment should be placed on a leveled surface.

3.1.1. BLOWER: the blower features 2 oil pans, one on the shaft side and one on the gear drive side. To have access to the filling plugs, remove the left guard of the machine. The recommended oil specification is ISO VG-220. The oil capacities are 0,25L (shaft side) and 0,40L (gear drive side). These volumes, however, are only references and the control should be made daily before starting the application, using the oil level indicators. The oil level should fill about half to $\frac{3}{4}$ of the indicator. In case the unit operates in very unlevelled terrain (e.g. on steep hills), keep the oil level between $\frac{3}{4}$ and $1/1$ of the indicator. A milky appearance of the oil indicates contamination with water. Should the milky aspect persist after more than 15 minutes after starting the application, it is recommended to change the oil. The recommended oil change period is every 500 working hours.

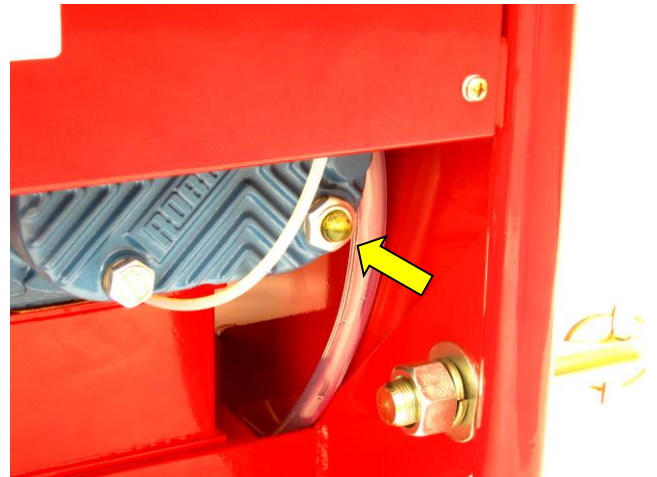

Blower oil level indicator (gear drive side)

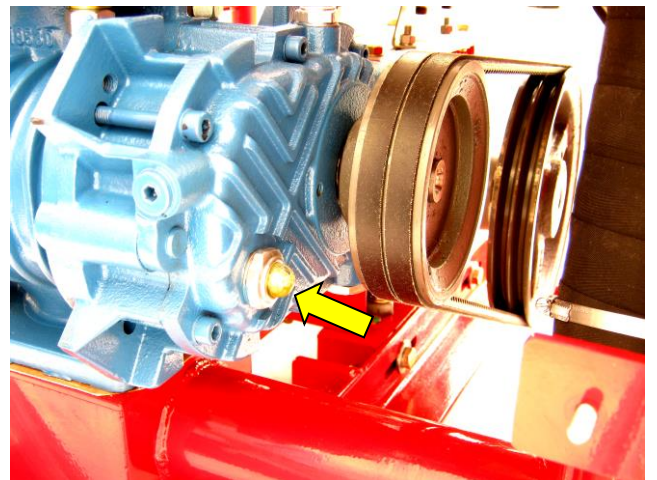

Blower oil level indicator (shaft side)

3.1.2. GEARBOX. To have access to the gearbox remove the right guard of the machine. Check the oil level of the gearbox daily, or before starting an application. The unit should be placed on a leveled surface. Check the oil level using the oil level indicator as shown in the picture below. The oil should fill half to $\frac{3}{4}$ of the indicator, or $\frac{3}{4}$ to 1/1 when operating in rough or steep terrain. The oil specification is ISO VG-220. The oil capacity is approximately 0,4L and the recommended oil change period for the gearbox is every 500 working hours.

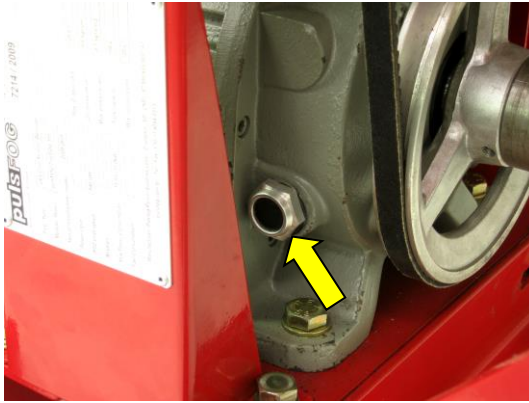

Gearbox with oil level indicator

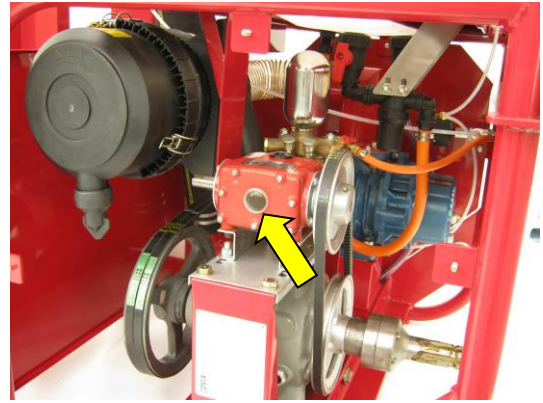

Formulation pump with oil level indicator

3.1.3. FORMULATION PUMP. To have access to the formulation pump remove the guard on the right side of the machine. The pump's crankcase is oil lubricated. The oil level should be checked daily. Keep the level indicator half to $\frac{3}{4}$ filled with mineral oil for gasoline engines. The oil change should occur every 50 working hours. The pump's pistons are lubricated by the two greaser cups shown in the Picture below. Turn both cups clockwise half a turn each 8 working hours. Remove and refill the cups with regular industrial grease when necessary.

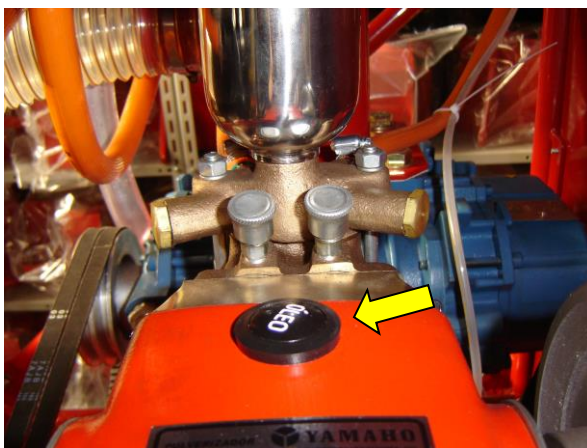

Oil refill.

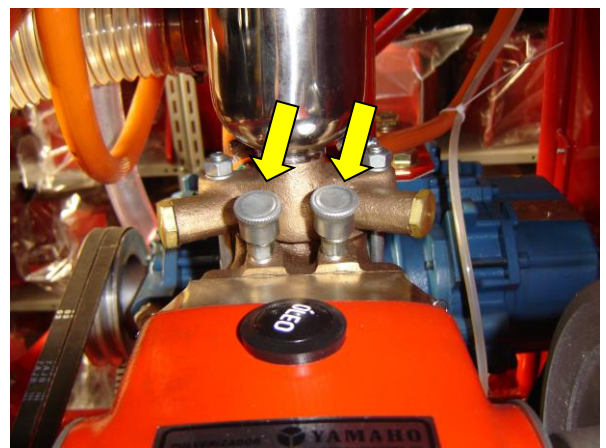

Greaser cups.

3.2. CHECKING THE FORMULATION AND AIR FILTERS

3.2.1. BLOWER INTAKE FILTER. The TracFOG 100 F features a two-stage air filter, which protects the blower from particles and liquid, avoiding excessive wear. To ensure that the unit runs with its full capacity, without compromising its service life, it is very important that the air filter is kept in clean and in good conditions. To access to the air filter remove the guard on the right side of the machine. Check the filter every 50 working hours. Substitute the filtering element #1 at least every 200 working hours. Do not run the unit if filtering element #1 is missing. Also, check regularly the air suction hose (which connects the filter to the blower) for punctures or loose clamps, which could compromise the efficiency of the filter.

Filtering element #1: ref. TR 1510 (compatible Ford F1000/2000/4000 / Mercedes Benz 709)



To open filter release butterfly nut.



To remove element release nut.

Filtering element #2 (safety filter): ref. TR 1910. Replace when visibly dirty



Air deflector

3.2.2. FORMULATION INLINE FILTER. The formulation inline filter is very important, as it will retain large solid particles and other residues that may find their way into the formulation tank, protecting the formulation pump. Therefore it is very important to check on the formulation filter daily, which will avoid unplanned stops, premature wear and failure of the pump.



Filter cup and strainer.



Before opening the filter, shut the formulation line ball valve (shown here in open position).

ATTENTION! For cleaning the filter wear the same protective gear recommended for preparing the fogging solution.

1. Shut the formulation line ball valve.
2. Unscrew the filter cup and pour its content into a proper container or back into the tank.
3. Remove the strainer from the cup and rinse it under running water. If necessary remove residues using a smooth brush (e.g. tooth brush). Rinse the cup to eliminate residues.
4. Reassemble and fasten the filter cup. Do not forget the sealing ring.
5. Open the formulation line ball valve.

3.3. SETTING AND MAINTAINING THE REVERSION SYSTEM

The reversion system on the TracFOG 100 F fogger allows the user to direct the nozzles to the left or the right side of the tractor's motion. In forestry applications, for instance, that feature allows to drive up and down the tree rows and reposition the nozzles pointing downwind after every turn.



Nozzles may be pointed to left side or right side of tractor's motion.

The unit's remote control panel features a power switch to operate the reversion. In order to work properly the unit must be connected to 12 VDC power and the PTO must be engaged and running at approximately 540 rpm. By switching on or off the power the reversion cylinder will actuate and turn the nozzles to the opposite side (right to left or left to right).



Reversion power switch

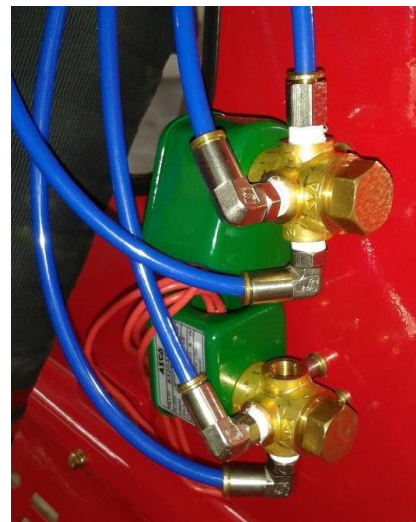

Reversion valves and pressure tubes

The power to produce the movement comes from compressed air generated by the unit's blower. Two 3-way solenoid valves direct the compressed air to either the left or the right chamber of the cylinder, moving the piston left or right.

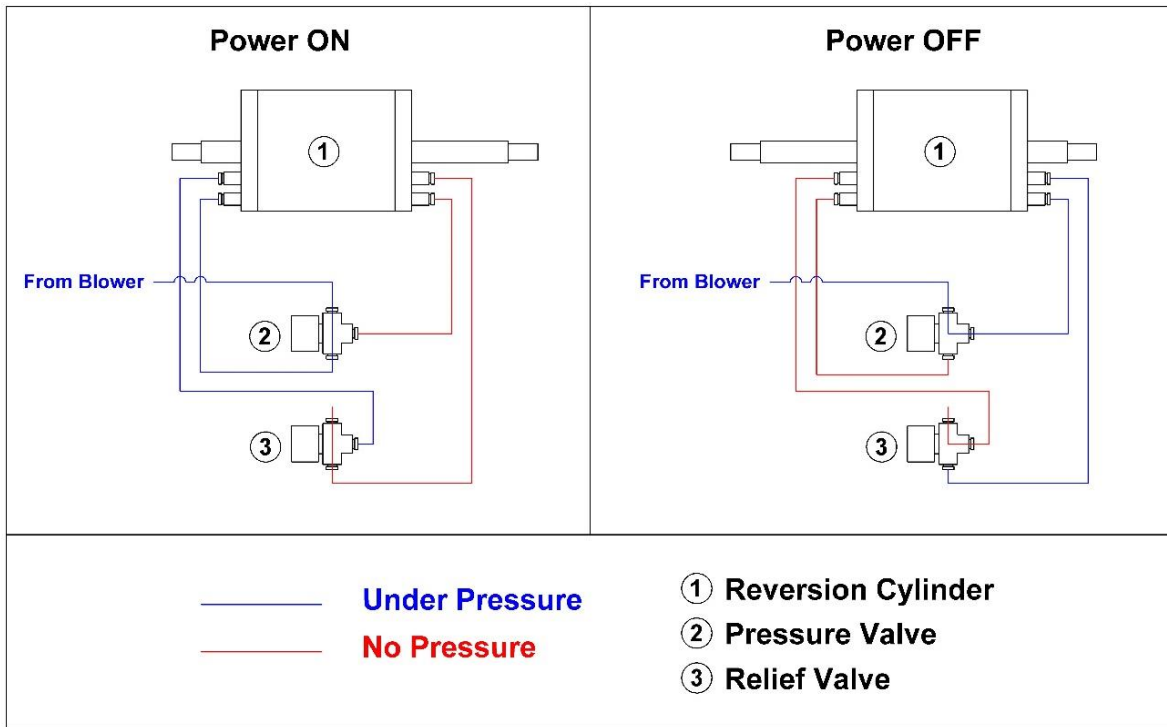

Reversion cylinder, pressure lines, valves, and their action to reverse nozzles.

Set nozzle angles by hand loosening the handles like shown below.

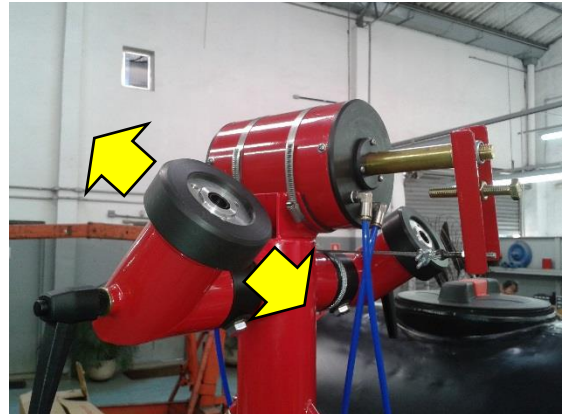
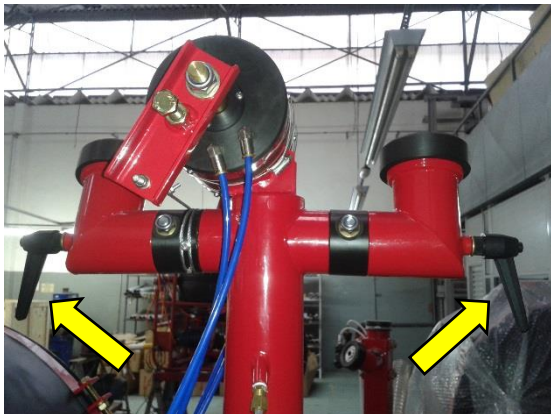

The cylinder's stroke can be set with the limiter screws shown below.

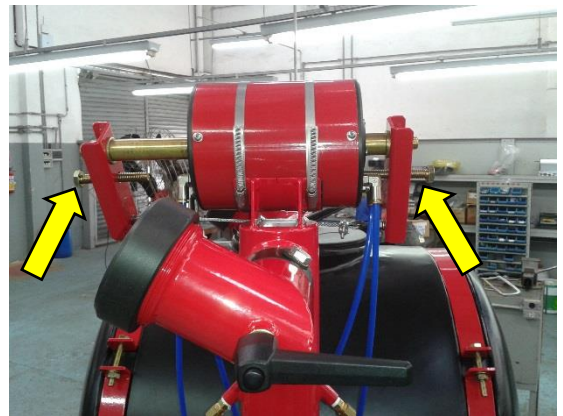

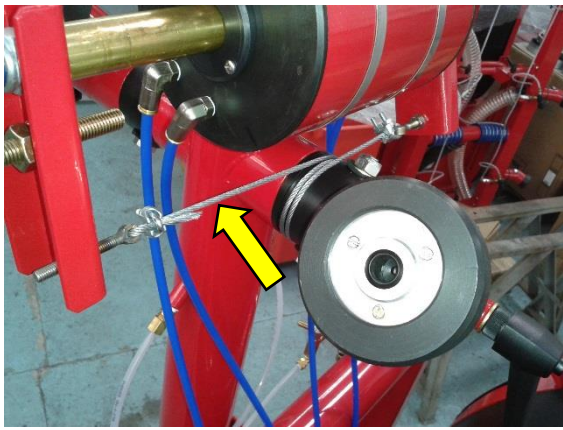

The steel cable, which transmits the pistons movement to the nozzles, must be slightly tensioned and fixed to the nozzles barrel.

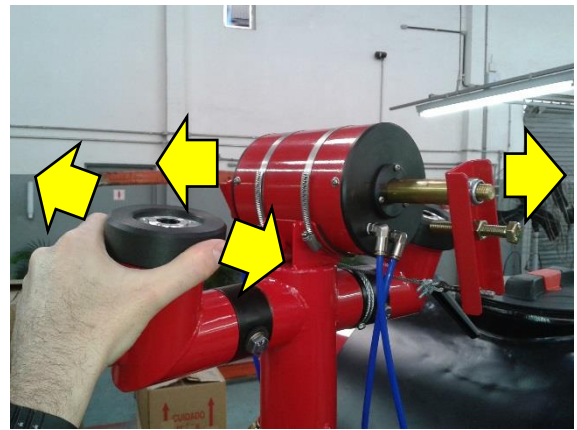

When the unit is not running, it should be possible to move the nozzles along with the piston from one side to the other by hand.

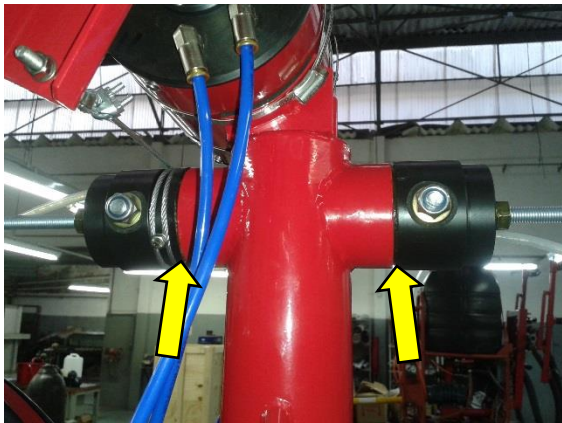

These barrels must be lubricated with **Molykote PG-75** grease. A small gap of 2 mm (arrows) between each barrel and the pole allows the barrels to rotate freely.



The barrels are linked together from the inside in order to turn simultaneously when the reversion is switched on or off.

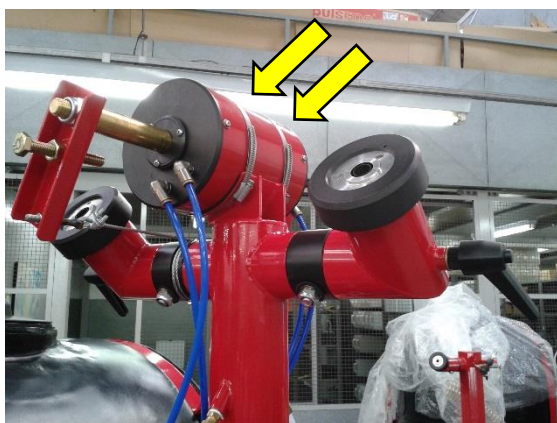

To ensure the mechanism to work properly, the cylinder must be properly fixed to the pole through the two clamps.

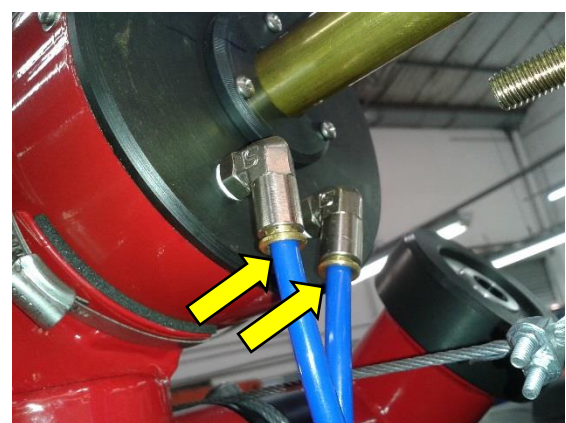

The blue air tubes must be properly connected according to the diagram shown on page 2. Do not switch air and formulation tubes!

FOGGING POLE, BARRELS AND NOZZLES ASSEMBLY

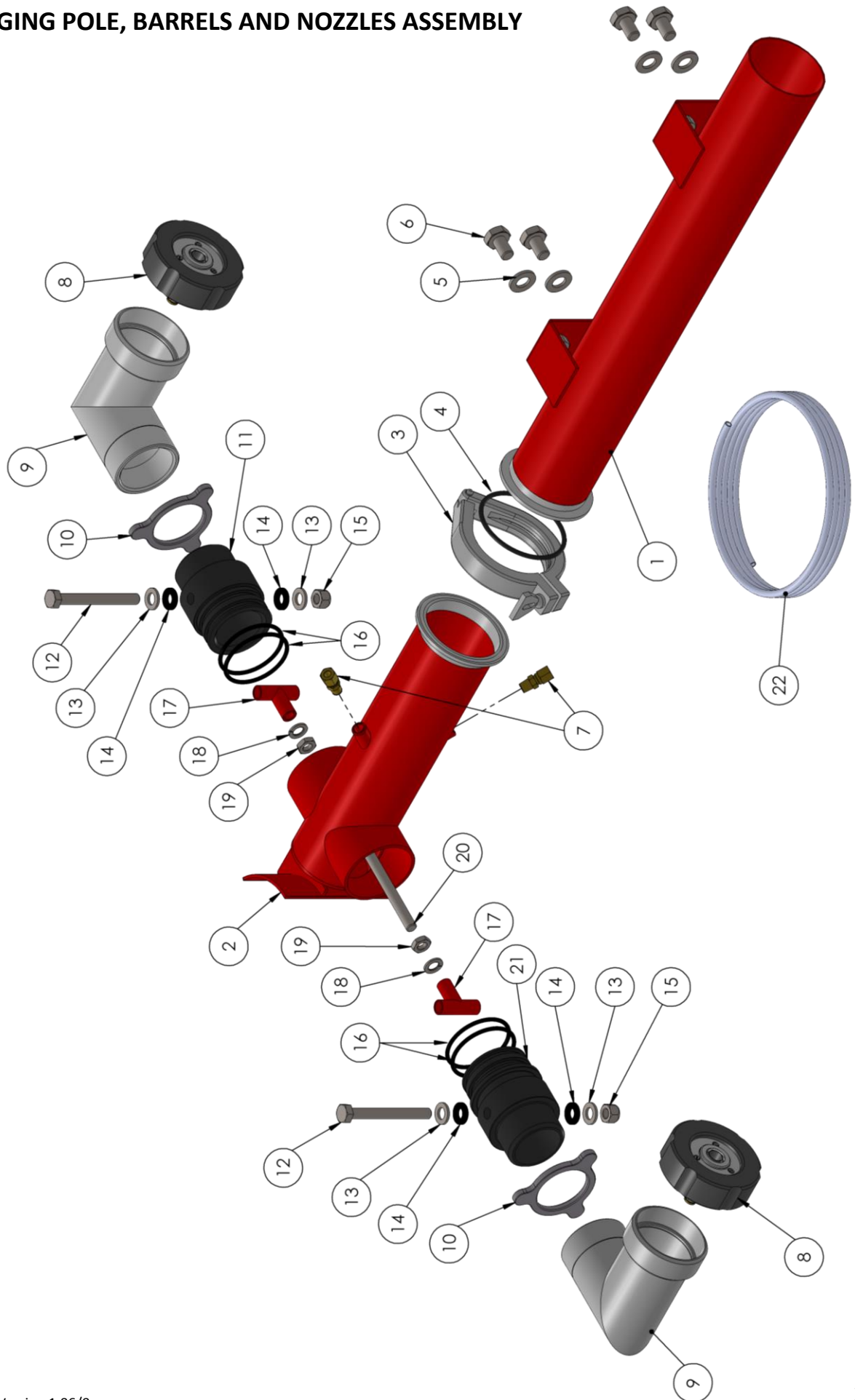

FOGGING POLE, BARRELS AND NOZZLES ASSEMBLY

Pos	Ref	Description	Qty
1/2	S00092.01	Fogging pole	1
3	C00782.00	Clamp	1
4	C00721.00	Sealing ring 78,97 x 3,53 mm	1
5	N00018.00	M12 washer	4
6	N00035.00	M12 x 25 hex screw	4
7	C00248.00	Formulation tube passage	2
8	S00108.00	Complete nozzle set	2
9	A00604.00	Nozzle holding elbow	2
10	A00480.00	Elbow locking ring	2
11	A00467.01	Rotating barrel, rear side	1
12	N00195.00	M10 x 80 hex screw	2
13	N00176.00	M10 washer	4
14	A00465.00	M10 rubber washer	4
15	N00108.00	M10 self-locking nut	2
16	C00659.00	Sealing ring 53,57 x 3,53 mm	4
17	A00588.00	T-piece	2
18	N00033.00	M10 locking washer	2
19	N00121.00	M10 low nut	2
20	M00041.00	M10 bolt 125 mm	1
21	A00466.01	Rotating barrel, front side	1
22	C00143.00	1/4 nylon tube (transparent)	-

Lubricate moving parts with **Molykote PG-75** high temperature grease.

REVERSING CYLINDER ASSEMBLY

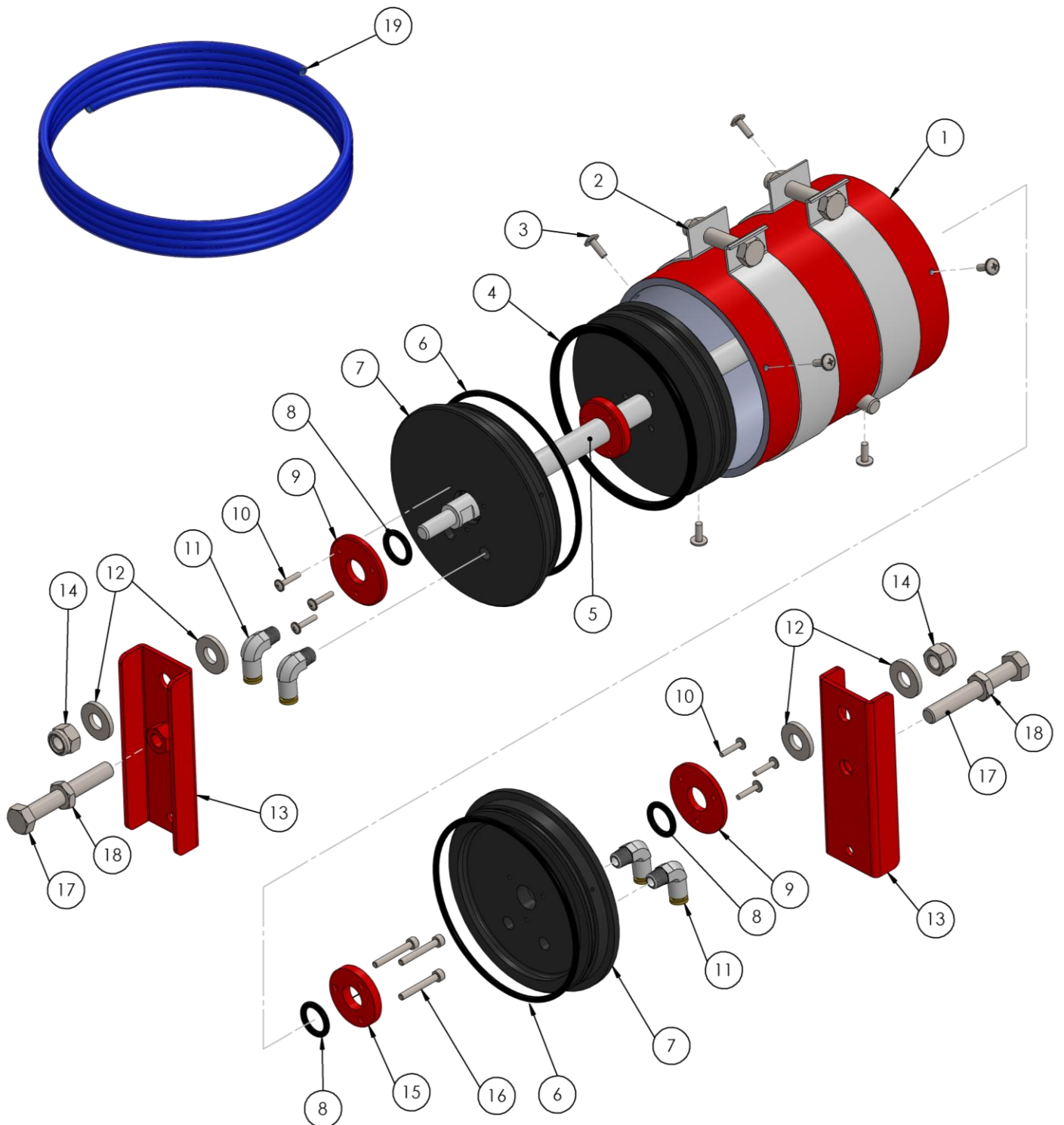

REVERSING CYLINDER ASSEMBLY

Pos	Ref	Description	Qty
1	A00476.01	Cylinder	1
2	C00782.00	Clamp	2
3	N00078.00	Self-tapping screw 25 mm	6
4	C00715.00	Sealing ring 113,67 x 5,33 mm	1
5, 15, 16	A00474.01	Piston bolt assembly	1
6	C00660.00	Sealing ring 113,89 x3,53 mm	2
7	A00472.01	Cylinder lid	2
8	C00657.00	Sealing ring 15,47 x 3,53 mm	3
9	A00471.00	Seal cover ring	2
10	N00159.00	Self-tapping screw 15 mm	6
11	C00503.00	1/4 x 1/8 quick elbow connector	4
12	N00176.00	M10 washer	4
13	A00468.01	U shaped piece	2
14	N00108.00	M10 self-locking nut	2
17	N00152.00	M10 x 70 hex screw	2
18	N00121.00	M10 low nut	2
19	C00689.00	1/4 nylon tube (blue)	-

Lubricate moving parts with **Molykote PG-75** high temperature grease.

3.4. OTHER PERIODIC CHECKS

3.4.1. CHECKING THE TENSION OF THE DRIVE BELTS. (Weekly or after every 50 working hours). Push the belts (one at a time) by hand. The belts should not yield more than 10 mm. If necessary tense the belts as shown in the pictures below. Make sure to keep the wheel properly aligned, to avoid excessive wear of the belts. When the belts become worn or show shredded edges they must be replaced. Use only belts of the same type and length as the originals. Make sure to tighten all screws before starting the machine.

Blower drive belts: 2 x A-52 or HA-52

Formulation pump drive belts: 1 x A-36 or HA-36

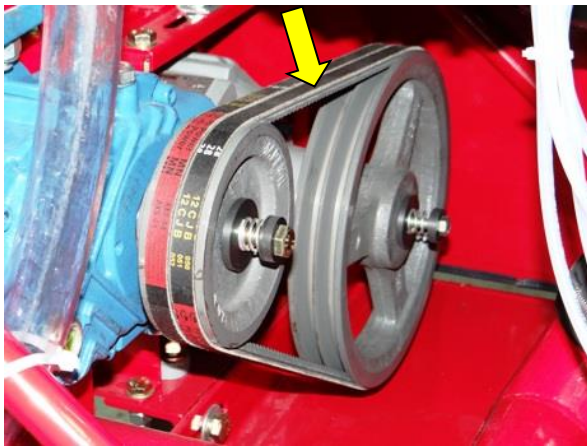

Check the tension of the blower drive belts.



Checking the pump belt.

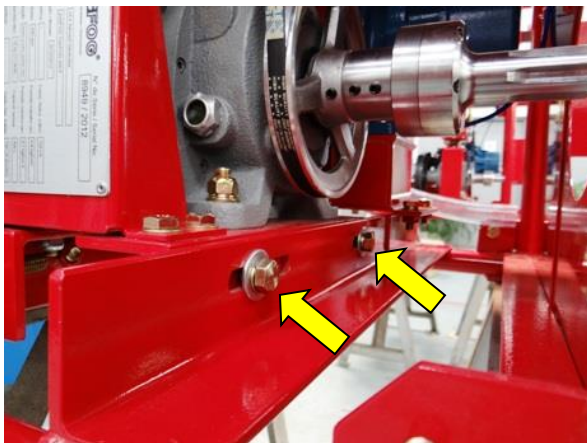

Fixing screws and screw tensioner.

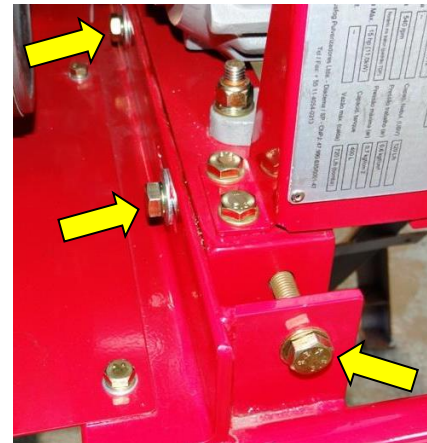

ATTENTION! Before performing any servicing that requires opening any of the equipments guards make sure the driveshaft is disconnected from the tractor, as moving parts such as wheels and belts are very hazardous and may cause severe injury or even death.

3.4.2. CLEANING THE FOGGING NOZZLES. Depending on the formulation used, the fogging nozzles may accumulate solid residues, which may block them and affect their efficiency. To disassemble the nozzles for cleaning, remove their locking rings (9) and remove the nozzle assemblies. To release the hose from a nozzle push the ring towards the quick-release connector and pull the hose out at the same time. To reseat the hose to the nozzle, simply push it back inside the connector. The cleaning of the nozzles should be performed using a smooth non-metallic brush. To remove more persistent residues, use kerosene or thinner. If necessary, disassemble the nozzle set releasing its three fixing screws. After cleaning its parts reassemble the nozzle set like shown on the picture below.

ITEM	DESCRIPTION	REF.	QTY.
1	Push-in quick release connector	C00538.00	1
2	Nozzle central piece	A00605.00	1
3	Deflector	A00606.00	1
4	Spacers	A00607.00	3
5	Restriction plate 18,9 mm	A00608.00	1
6	M3 x 25 screws	N00063.00	3
7	Locking ring 75 mm	A00143.00	1
-	Complete nozzle set (parts 1 – 7)	S00108.00	1

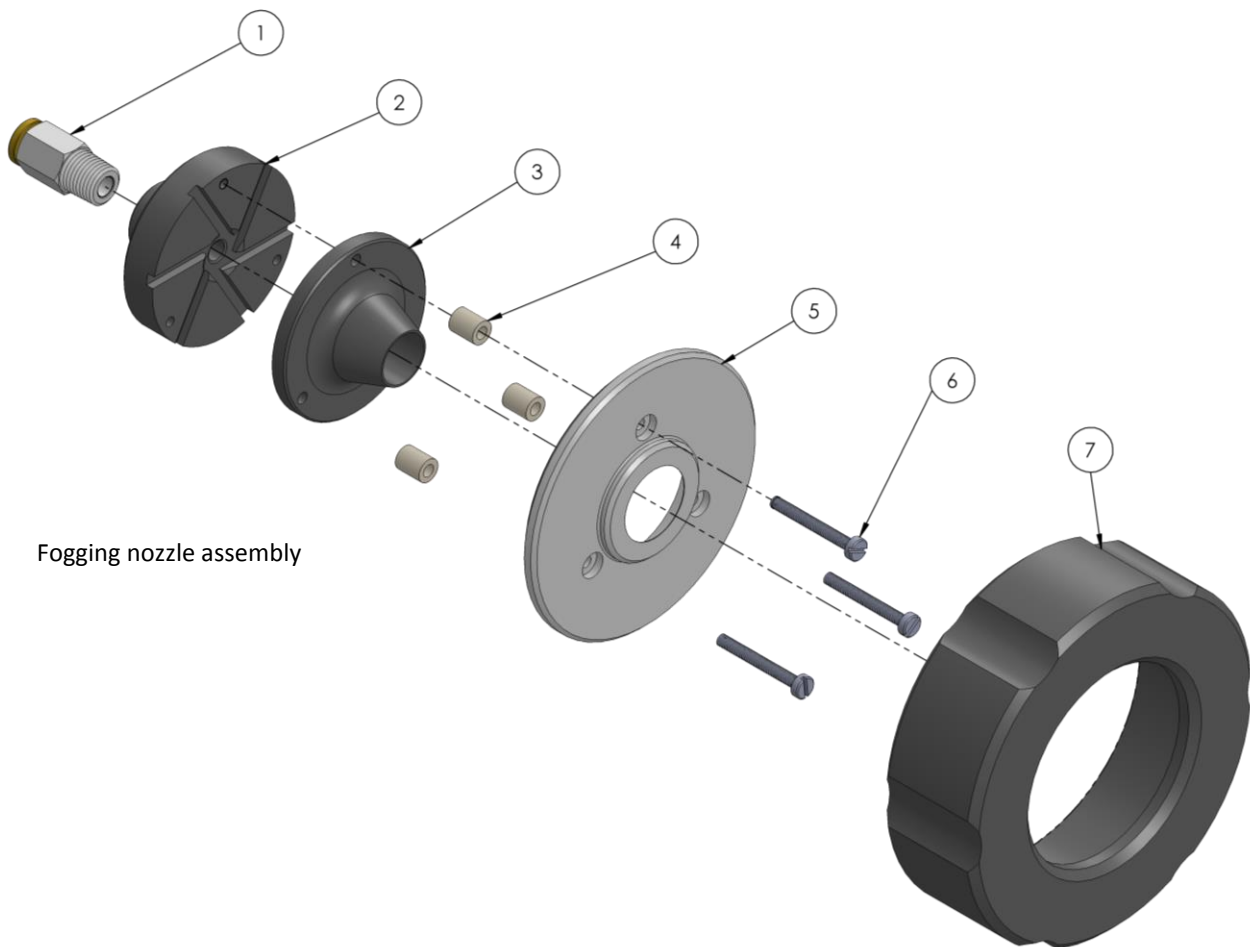

3.4.3.MAINTENANCE OF THE ANTI-DRIP VALVES

The anti-drip valves shut the formulation lines to the fogging nozzles as soon as the pressure in the lines drops below 15 psi. This prevents formulation dripping from the nozzles after the machine is turned off. The anti-drip valves open as soon as there is around 15 psi pressure on the spray line, and the solution flow is reestablished.

The anti-drip valves may get stuck or blocked by formulation residues. If that happens, disassemble and clean the valves.



One of two anti-drip valves on the TracFOG 100 F

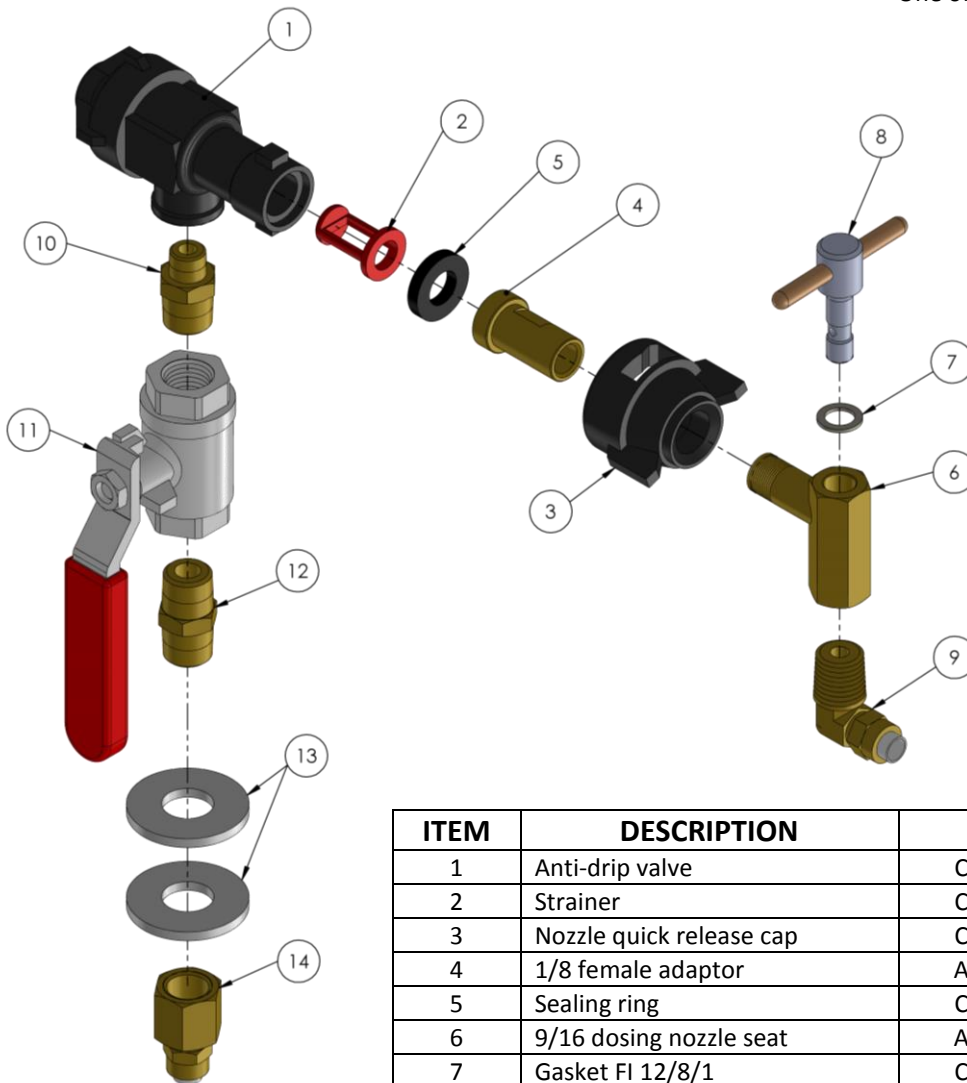

ITEM	DESCRIPTION	REF.	QTY
1	Anti-drip valve	C00581.00	1
2	Strainer	C00580.01	1
3	Nozzle quick release cap	C00585.00	1
4	1/8 female adaptor	A00611.00	1
5	Sealing ring	C00584.00	1
6	9/16 dosing nozzle seat	A00464.00	1
7	Gasket FI 12/8/1	C00213.00	1
8	Dosing jet	A00075.00	1
9	1/4 x 1/8 male elbow	C00678.00	1
10	1/4 x 1/8 adaptor	C00497.00	1
11	1/4 ball valve	C00125.00	1
12	1/4 x 1/4 adaptor	C00530.00	1
13	M14 Washer	N00140.00	1 (2)
14	1/4 x 1/8 female adaptor	C00710.00	1

3.5. SERVICING SCHEDULE

PERIOD	EVENT	DIRECTIONS
DAILY	Check oil level on blower on both sides (shaft and gear drive side).	If necessary, complete level using ISO VG-220 synthetic oil.
	Check oil level on gearbox.	If necessary, complete level using ISO VG-220 synthetic oil.
	Check oil level on formulation pump.	If necessary, complete level using mineral oil for gasoline engines. ⁽¹⁾
	Clean formulation filter.	-
	Grease formulation pump pistons.	If necessary refill with regular mineral grease.
Every 50 working hours	Formulation pump oil change	Use mineral oil for gasoline engines. ⁽¹⁾
	Check the blower intake filter	TR 1510 filter element
	Check tension of blower drive belts.	A-44 or HA-44 belts
	Check tension of formulation pump drive belt.	A-38 or HA-38 belt
Every 200 working hours	Change blower intake filter element.	TR 1510 filter element
Every 500 working hours	Blower oil change (both oil pans).	ISO VG-220 synthetic oil
	Gearbox oil change.	ISO VG-220 synthetic oil

(1) – Acceptable oil specifications for the formulation pump: SAE 10W40 / SAE 5W40 / SAE 10W30 / SAE 5W30

3.6. TRACFOG 100 F WIRING DIAGRAM

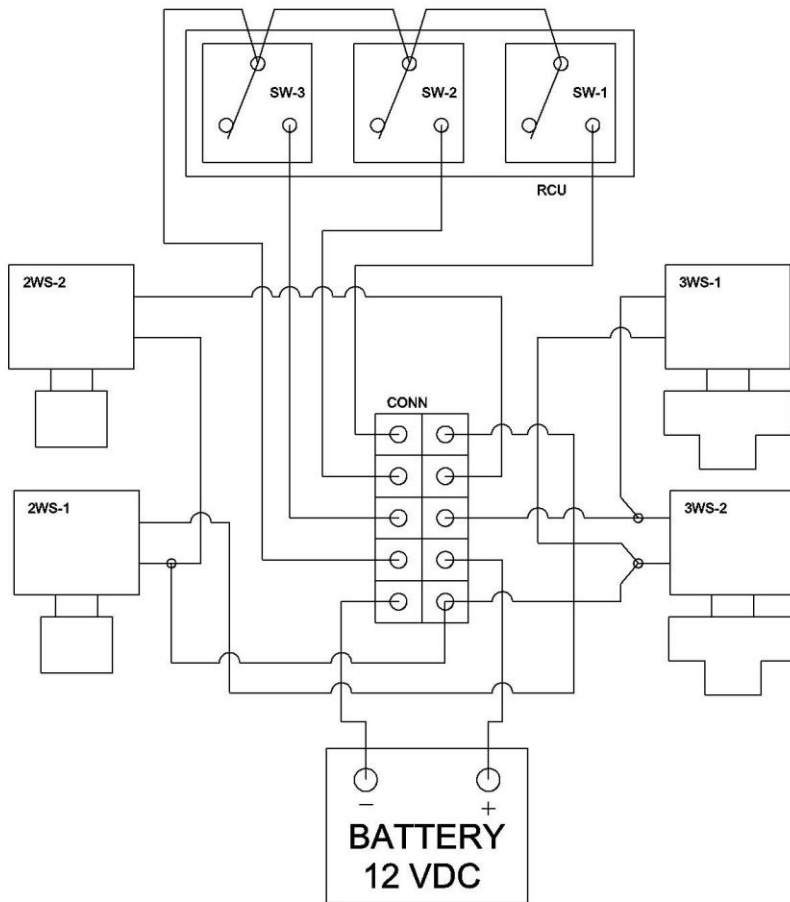

DESCRIPTION	
RCU	Remote control unit
SW-1	Switch for nozzle #1
SW-2	Switch for nozzle #2
SW-3	Reverser switch
CONN	Connectors
2WS-1	Two-way solenoid valve #1
2WS-2	Two-way solenoid valve #2
3WS-1	Three-way solenoid valve #1
3WS-2	Three-way solenoid valve #2